

X2G100ND06P1

HIGH POWER NPT Low loss TYPE 2-PACK IGBT MODULE



600V
100A

PACKAGE : M1

PRELIMINARY

■ CIRCUIT DIAGRAM

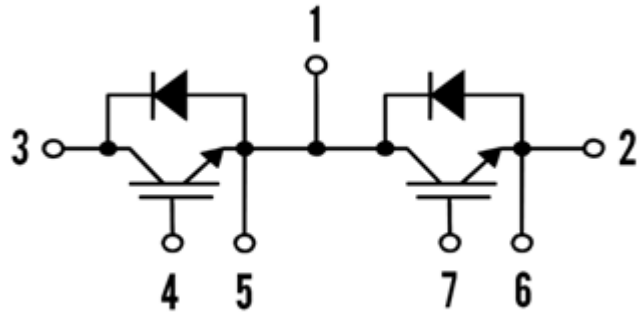

■ FEATURES

- Non Punch Through (NPT) Technology
- Fast & soft inverse CAL diodes
- 10us short circuit capability
- Positive $V_{CE(on)}$ temperature coefficient
- Industry standard package

■ APPLICATIONS

- High power inverter
- Switched mode power supplies (SMPS)
- UPS
- Electrical welding machine

■ ABSOLUTE MAXIMUM RATINGS

$T_c=25^\circ\text{C}$, unless otherwise specified

Symbol	Parameter	Conditions	Ratings	Unit
V_{CES}	Collector-emitter voltage	-	600	V
I_C	DC-collector current	$T_C = 25^\circ\text{C}$	130	A
		$T_C = 70^\circ\text{C}$	100	A
I_{CRM}	Repetitive peak collector current	1ms	200	A
V_{GES}	Gate-emitter peak voltage	-	± 20	V
I_F	Diode continuous forward current	-	100	A
I_{FRM}	Diode repetitive peak forward current	-	200	A
$T_{vj,max}$	Maximum junction temperature	-	-40 ~ 150	$^\circ\text{C}$
$T_{vj,op}$	Operating temperature range	-	-40 ~ 125	$^\circ\text{C}$
T_{stg}	Storage temperature range	-	-40 ~ 125	$^\circ\text{C}$
V_{ISOL}	Insulation test voltage	50/60Hz, $t=1\text{min}$ $I_{ISOL}=1\text{mA}$	2.5	kV
M_S	Mounting screw torque	M6	3.0 ~ 6.0	N.m
M_t	Mounting terminals screw torque	M5	2.5 ~ 5.0	N.m

Technical information and specification subject to change without notice.

PRELIMINARY

T_J=25 °C unless otherwise specified

ELECTRICAL CHARACTERISTICS OF IGBT

Symbol	Parameter	Min	Typ	Max	Unit	Conditions
V _{CE(Sat)}	C-E saturation voltage	-	2.1	-	V	I _C = 100A, V _{GE} = 15V, T _{vj} = 25 °C
		-	2.3	-	V	I _C = 100A, V _{GE} = 15V, T _{vj} = 125 °C
V _{GE(th)}	G-E threshold voltage	4.5	5.5	6.5	V	I _C = 1mA, V _{CE} = V _{GE}
I _{CES}	Zero gate voltage collector current	-	-	500	μA	V _{GE} = 0V, V _{CE} = 600V
I _{GES}	G-E leakage current	-	-	0.4	μA	V _{GE} = ±20V
R _{Gint}	Internal gate resistance	-	-	-	Ω	-
C _{ies}	Input capacitance	-	4.3	-	nF	V _{GE} = 0V, f = 1MHz, V _{CE} = 25V
C _{oes}	Output capacitance	-	0.5	-		
C _{res}	Reverse transfer capacitance	-	0.4	-		
Q _g	Total gate charge	-	tdb	-	μC	V _{GE} = ±15V
t _{d(on)}	Turn-on delay time	-	95	-	ns	V _{CE} = 300V, I _C = 100A, V _{GE} = ±15V, R _G = 2.2Ω, T _{vj} = 125 °C
t _r	Turn-on rise time	-	30	-		
t _{d(off)}	Turn-off delay time	-	200	-		
t _f	Turn-off fall time	-	35	-		
E _{ON}	Turn-on Energy loss	-	1.0	-	mJ	
E _{OFF}	Turn-off Energy loss	-	2.9	-		

ELECTRICAL CHARACTERISTICS OF FRD

T_J=25 °C unless otherwise specified

Symbol	Parameter	Min	Typ	Max	Unit	Conditions
V _F	Diode Forward Voltage Drop	-	1.4	-	V	T _{vj} = 25 °C
		-	1.35	-		T _{vj} = 125 °C
I _{rr}	Peak Reverse Recovery Current	-	67	-	A	I _F = 100A, V _{CE} = 600V
Q _{rr}	Diode Recovery Charge	-	14	-	μC	V _{GE} = -15V T _{vj} = 125 °C

THERMAL AND MECHANICAL CHARACTERISTICS

T_J=25 °C unless otherwise specified

Symbol	Parameter	Min	Typ	Max	Unit	Condition
R _{th(j-c)}	Junction-to-Case (IGBT Part, Per 1/2 Module)	-	0.28	-	K/W	
R _{th(j-c)}	Junction-to-Case (FRD Part, Per 1/2 Module)	-	0.78	-	K/W	
R _{th(c-f)}	Case-to-Heat Sink (With Thermal Compound)	-	0.05	-	K/W	
Weight	Module		180		g	

Technical information and specification subject to change without notice.

PRELIMINARY

PERFORMANCE CURVES (I)

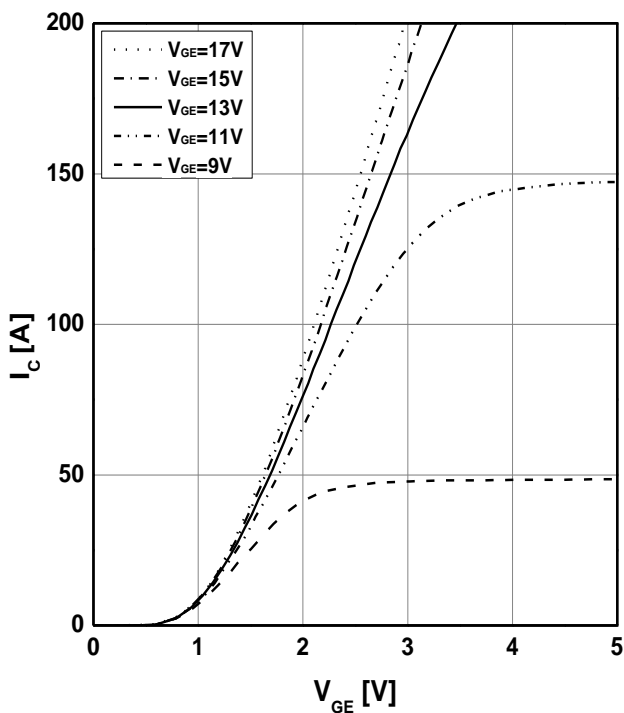

Fig1. Typical Output Characteristics

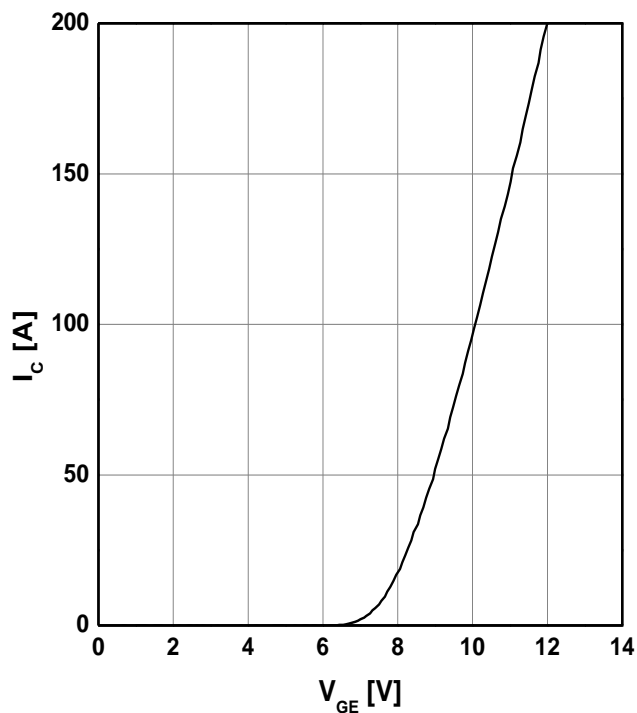

Fig2. Transfer Characteristics

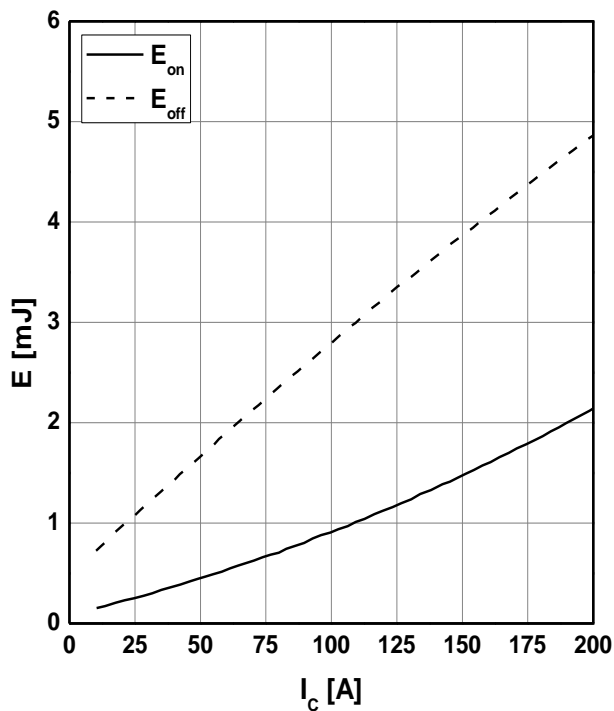

Fig3. Energy Loss vs. I_c

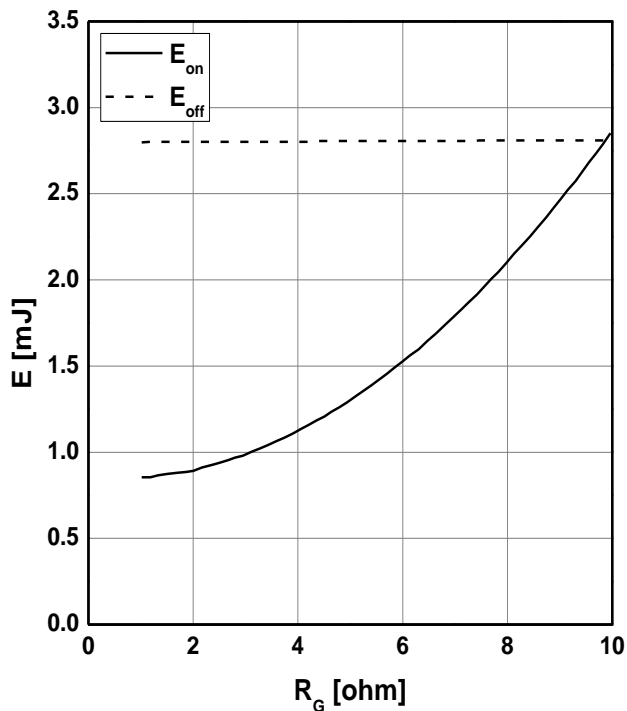

Fig4. Energy Loss vs. R_G

PRELIMINARY

■ PERFORMANCE CURVES (II)

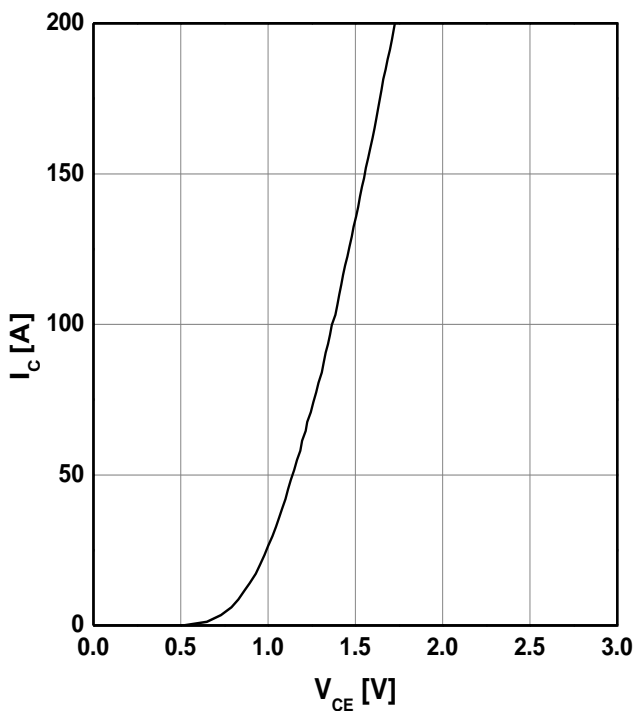

Fig5. DIODE Forward Characteristic

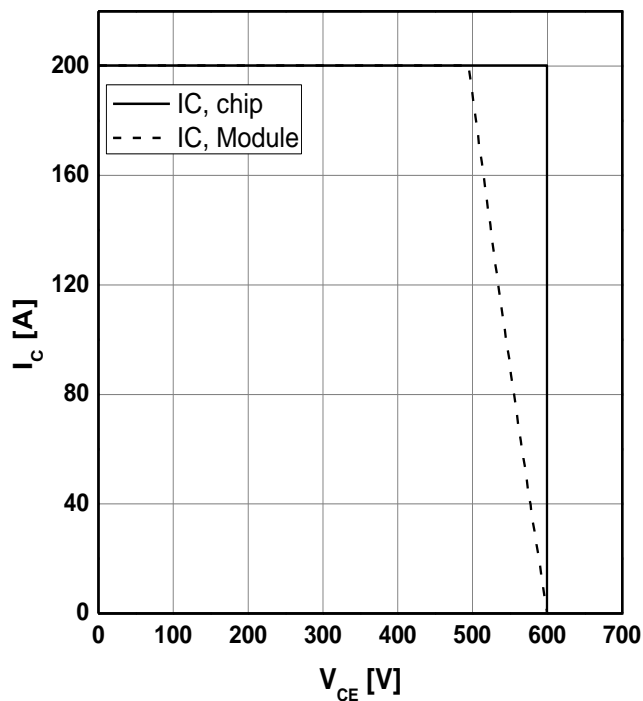

Fig6. Reverse Bias SOA ($T_{vj} = 125^{\circ}\text{C}$)

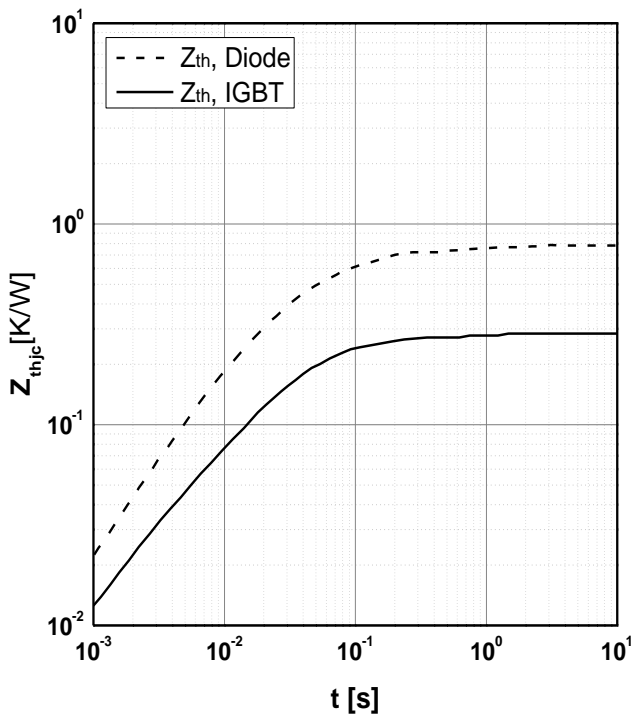

Fig7. Transient Thermal

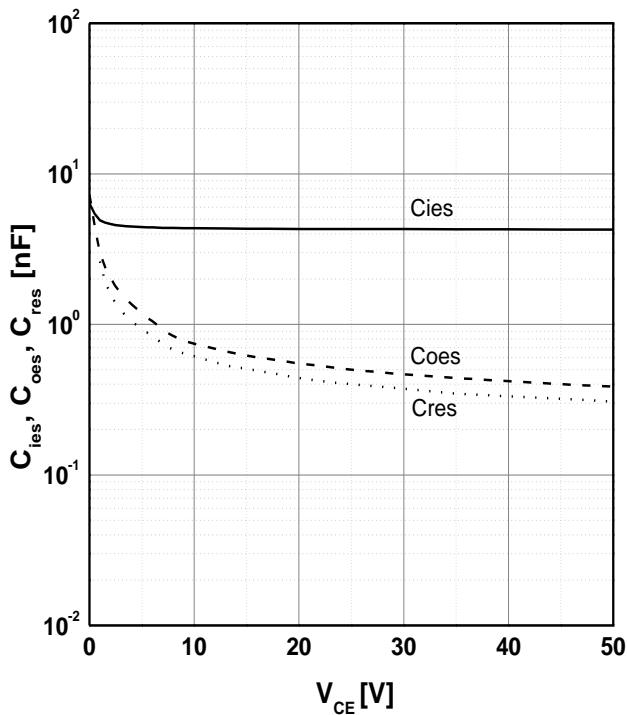

Fig8. Typ. Capacitance

Technical information and specification subject to change without notice.

PRELIMINARY

PACKAGE OUTLINES

